



IKH6066

LAAKERIN ASENNUSSARJA

Käyttöohje

Alkuperäisten käyttöohjeiden käännös

OMINAISUUDET

FI

- Soveltuu pyöränlaakereiden asentamiseen ja irrottamiseen sekä pyörännapojen asentamiseen.
- Aikaa säästävä, sillä ripustuksia ei tarvitse irrottaa eikä pystykallistuskulmaa säätää. ABS-jarruilla varustetuissa ajoneuvoissa myöskään ABS-anturia ei tarvitse irrottaa.
- Erittäin tehokas kierrekara mahdollistaa suuremman aksiaalivoiman vähemmällä väännöllä.
- Keskitysholkki mahdollistaa aksiaalisen ohjautuvuuden, mikä aikaansaa optimaalisen keskityksen kun pyörännapaa asennetaan uuteen pyöränlaakeriin.

SISÄLTÖ

- 1 kpl kierrekara
- 1 kpl karamutteri
- 3 kpl välilevyt
- 3 kpl rungot
- 8 kpl keskitysholkit
- 10 kpl painealuslevyt
- 2 kpl muunnosrenkaat

OSAT

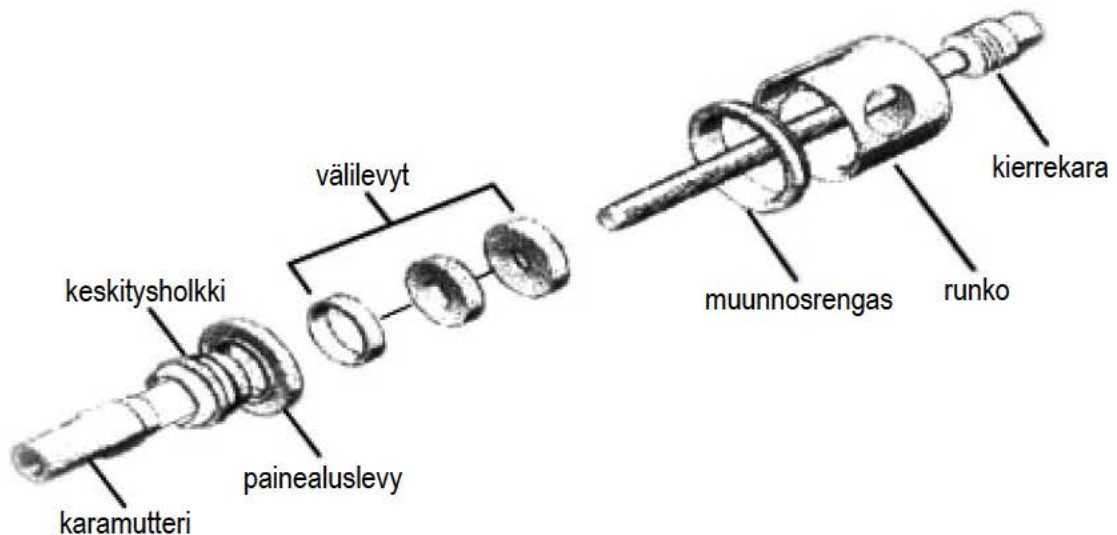



IKH6066

BEARING INSTALLATION SET

Instruction manual
Original manual

FEATURES

GB

- Suitable for installing and removing wheel bearings as well as for installing wheel hubs.
- Time-saving because you do not need to remove the suspension or adjust the camber. Furthermore, dismounting the ABS-sensor is not necessary in vehicles with anti-lock braking system.
- High-capacity threaded spindle enables higher axial forces with lesser torsion.
- Centering bushing enables axial guidance which allows optimal centering when inserting the wheel hub into the new wheel bearing.







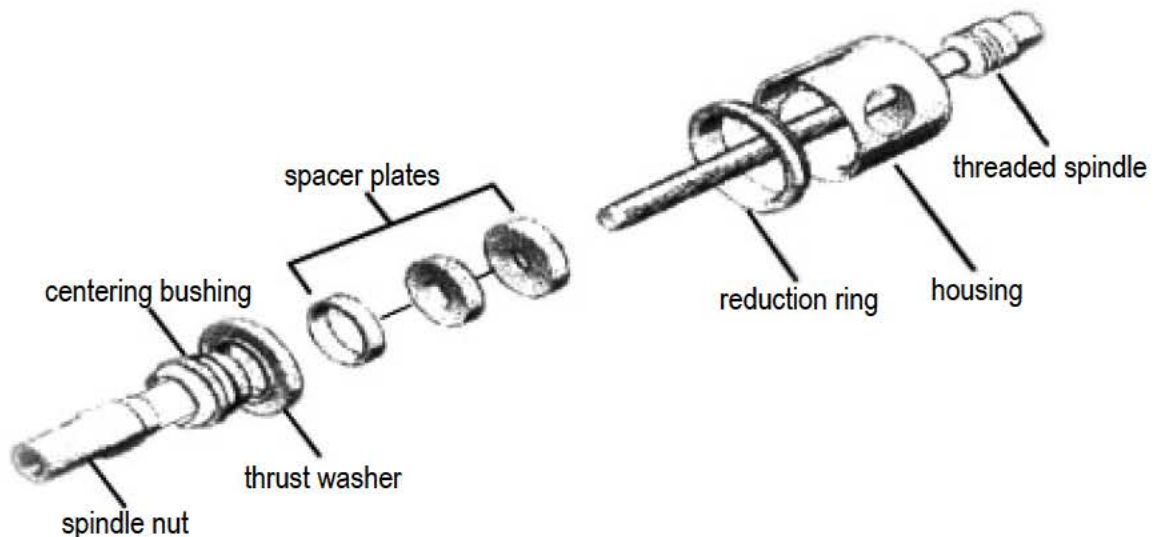

CONTENT

- 1 pc threaded spindle
- 1 pc spindle nut
- 3 pcs spacer plates
- 3 pcs housings
- 8 pcs centering bushings
- 10 pcs thrust washers
- 2 pcs reduction rings

PARTS



KÄYTTÖKOHTTEET • APPLICATIONS

	VW/AUDI SEAT, SKODA OPEL, FORD A588516-1	RENAULT, PEUGEOT, CITROEN(PSA) A588515-2	VW/AUDI SEAT, SKODA A588515-3	MERCEDES -BENZ A588512-4	BMW A588513-5	OPEL A588512-6	FORD A588511-7	PEUGEOT A588511-8	RENAULT A588512-9
 A588-1 Kierrekara Threaded spindle	●	●	●	●	●	●	●	●	●
 A588-2 Karamutteri Spindle nut	●	●	●	●	●	●	●	●	●
 A588-3 Välilevy Spacer plate	●	●	●	●	●	●	●	●	●
 A588-4 Välilevy Spacer plate	●	●	●	●	●	●	●	●	●
 A588-5 Välilevy Spacer plate	●	●	●	●	●	●	●	●	●
A588-6 Runko / Housing									
 A588-6-720	●	●	●		●	●	●	●	●
A588-6-820	●	●	●		●	●	●	●	
A588-6-850		●		●					●
A588-7 Keskitysholkki Centering bushing									
 A588-7-34	●		●			●			
A588-7-35	●	●	●		●		●	●	●
A588-7-37		●		●	●				●
A588-7-39	●		●		●	●	●		
A588-7-40	●	●	●		●	●			●
A588-7-41	●		●		●	●	●		
A588-7-42		●		●	●			●	
A588-7-45		●		●	●				●
A588-8 Painealuslevy Thrust washer									
 A588-8-62	●		●						
A588-8-64	●	●		●		●			●
A588-8-66	●		●						
A588-8-68	●		●						
A588-8-72	●	●	●		●	●	●	●	●
A588-8-74	●		●	●	●	●	●		
A588-8-80					●				
A588-8-82			●						
A588-8-84		●		●					●
A588-9 Muunnosrenkas Reduction ring									
 A588-9-61									
A588-9-74				●					